

## Ultra2 68pin Removable Tray & Frame, Aluminum

### Packing List - Check Contents Prior To Installation:

- 1) 1 - 5.25" Aluminum 68pin Frame
- 2) 1 - 3.5" Aluminum 68pin Tray
- 3) 1 - Screw/Key Pack
- 3) 1 - Installation Guide

### Electrostatic Discharge

Many components on your hard disk are susceptible to electrostatic discharge. To prevent damage to these components, take careful precautions before handling your hard disk.

### Remove the Casing for your Tower/Enclosure

1. Unplug the computer, as well as all peripheral devices and cables.
2. Referring to the owner's manual for your computer or enclosure, remove the outer casing.
3. Referring to the owner's manual for your computer or enclosure, remove any front panel or bezel on the 5.25" bay you plan on installing your tray & frame in.

### Install the Frame

1. Place the Frame into the 5.25" Bay with the backplane of the Frame toward the rear of the bay. To determine which side of your frame is the top, view the frame from the back (**Figure 2**) if the fan is on the left side, you are holding the frame right side up.
2. Line up the four bracket holes in the frame with the corresponding holes in your 5.25" bay. Using the screws which can be found inside of your tray (along with the keys to the tray lock), fasten the frame into the bay.
3. With the frame securely fastened, slide the tray into the frame to ensure that the tray fits snugly but smoothly into the frame. Be sure that the tray is right side up by viewing the front (handle side) of the tray. If the tray is right side up, the lock will be visible on the right side of the tray. As the tray is slid into the frame, apply even pressure to both sides of the tray to ensure a proper connection.
4. Remove the tray by gently lifting on the FORCE-LESS<sup>SM</sup> handle until the tray is dislodged from the frame. Then, gently pull on the tray with the handle until the tray is completely removed from the frame assembly.

### Make Wire Connections Between Frame and Enclosure

1. With the frame mounted in the enclosure, turn the enclosure so that you have a clear view of the backplane of the frame. Connect the 68 pin HDD controller cable and the power cable.
2. Referring to **Figure 3**, as well as the documentation provided with your enclosure, connect the SCSI ID cables to the five connectors as shown in Figure 3. Please note that not all enclosures come with a connector for the "8" pin, and this pin is not required for normal operation of the enclosure, tray, or drive.

Figure 1

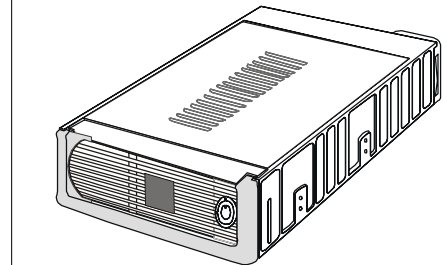

Figure 2

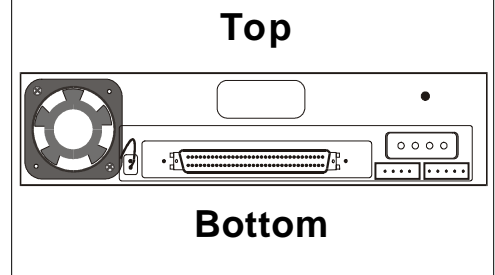
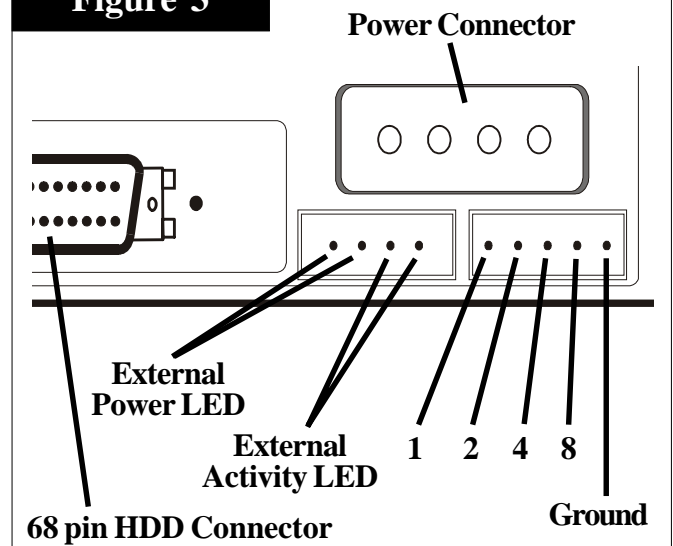

Figure 3



(MORE)

## Install Hard Drive into tray

NOTE: Please reference the documentation that came with your hard drive for diagrams which show the SCSI pin location(s) on your drive.

1. Open your DataTrans tray by pulling the side of the tray cover away from the railing and firmly lifting of the cover. If you have difficulty, try using a pen knife or watchmaker's screw driver to separate the cover from the railing. NOTE: You can remove either the top or bottom cover in this fashion, and the drive can be mounted/accessed with either or both of the covers removed.
2. Inside your tray you will find several sets of cabling, including a four-pin power connector, a 68pin HDD controller connector, and a block connector containing seven wires that control SCSI ID and the Activity LED. (See **Figure 4**).
3. Referencing the manual that came with your drive, plug the SCSI ID cable into the appropriate SCSI ID Jumper Block on your drive. **Figure 5** provides a nomenclature color diagram for the SCSI ID cabling inside the tray, and **Figure 6** provides an example of how the connector will fit on the rear jumper block of most drives.

**NOTE:** A **full-color** version of **Figure 5** is available via a PDF form on DataStor's website. Go to [www.dstor.com/products](http://www.dstor.com/products) and then click on the "PDF Installation Guides" Link on the bottom of that page. From there, click the "DT51UWS-A" link to access the appropriate PDF file.

**NOTE:** Some drive manufacturers list the 1,2,4,8 SCSI ID signaling pins as jumper sets 0,1,2 and 3 respectively. If this is the case with your drive documentation, please note that set 0=1 signal, set 1=2 signal, set 2=4 signal and set 3=8 signal.

4. Plug the four-pin power connector and the 68 pin HDD controller connector into the drive.
5. Mount the drive into the tray using the four screws provided.
6. Replace the cover by following the reverse procedure for removing it in step 1.

## Install Tray into Frame

1. Set your SCSI ID using the rotational switch located on the bottom right of the frame (Figure 7). If you are planning on using an external SCSI ID switch, then set the rotary switch to "0".
2. Insert your tray into it's frame as defined in step 3 of "Install the Frame". Using the keys provided, insert a key into the lock on the tray and lock the device into it's frame. **Please note that the drive will not receive any power until the tray is locked into the frame.**

## Replace Enclosure Cover

1. Following the documentation provided by the manufacturer of your enclosure, replace the cover of the enclosure.

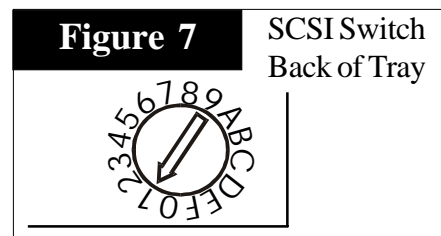
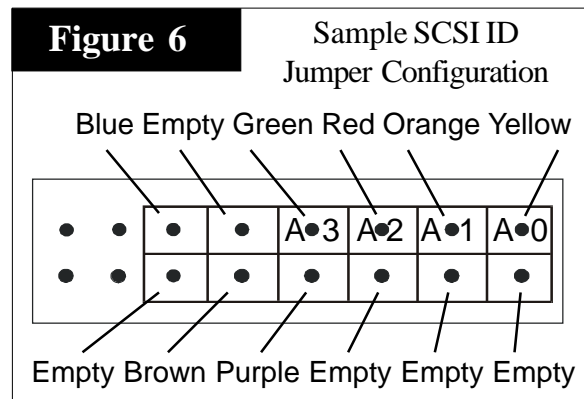
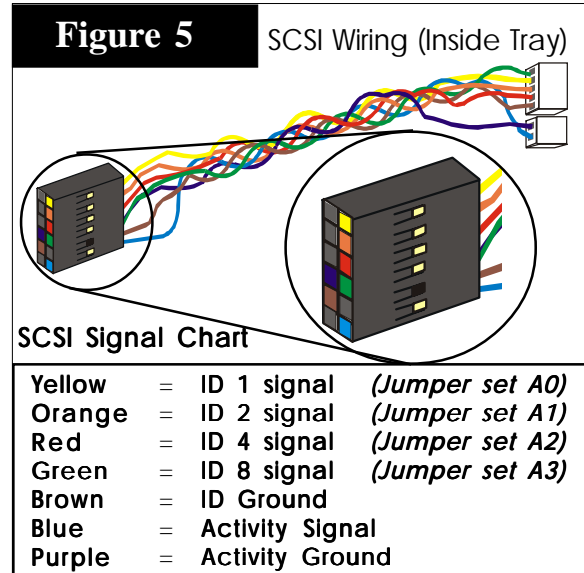
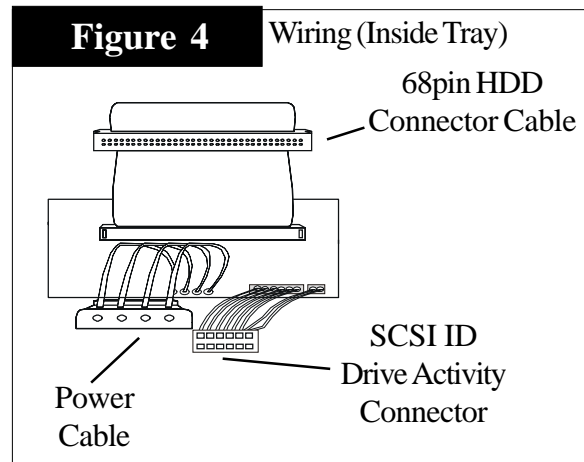

**DataStor, 12601 Monarch Street, Garden Grove, CA 92841-3918**  
**Phone (800) 777-6621 / Fax: (714)833-9600 / Web Site: [www.dstor.com](http://www.dstor.com)**

Installation Guide - DataTrans 68 pin Aluminum Removable Tray&Frame Rev 1.0 - November 1999 - P/N DT51UWSX-A

Copyright 1999 by DataStor, Inc. All rights reserved. No part of this document may be reproduced in any form without prior written consent from DataStor. The information and specifications in this document are subject to change without notice. Changes to this document are incorporated in new versions. DataStor, and the DataStor logo are registered trademarks of DataStor, Inc. Other trademarks used herein are the property of their respective owners. This document was printed in the United States Of America.